

X-Band Coaxial Pulsed Magnetron - 2,000 kW

L6170-03

The L6170-03 is a high output power coaxial pulse magnetron that delivers 2,000 kW minimum peak output power at a duty cycle of up to 0.00012 and a pulse width of up to 4.0 μ Sec.



Performance Characteristics	
Frequency	9.275 – 9.325 GHz
Peak Pulse Power Output	2,000 kW min
Average Power Output	240 W
Peak Anode Voltage	34 to 38 kV
Peak Anode Current	93 A
Average Anode Current	12 mA
Pulse Width	4.0 μ Sec
Duty Cycle	00.00012
Filament Voltage (Standby)	10 V
Filament Current (Standby)	15 A
Filament Voltage (Oscillating)	2 V (back-down required)
Warm-up time	300 Sec.
Load VSWR	1.2:1 max
Environment	
Cooling	Laboratory environment water cooling to anode & tuner
Flow Rate (Operating)	1.0 gallon / min
Max Inlet temp (Operating)	+45 °C
Max Outlet temp (Operating)	+85 °C
Temperature Range (Ambient Air).	5 °C to 40 °C
Mechanical Description	
RF Launch Type	WR-112 mates with UG-51/U flange
Weight (nominal)	35 lb. (16 Kg)
Outline dimensions	See outline drawing (page 2)
Mounting position	Any orientation
Tuning	10 turns, nominal

KEY FEATURES

- * Linear accelerator applications
- * 9.3 GHz, high frequency stability
- * Tunable +/- 25 MHz to match accelerator
- * 2,000 kW peak output power
- * 0.00012 duty cycle
- * Liquid cooled anode
- * Integral permanent magnets

X-Band Coaxial Pulsed Magnetron - 2,000 kW

L6170-03

L6170-03 Outline (inches)

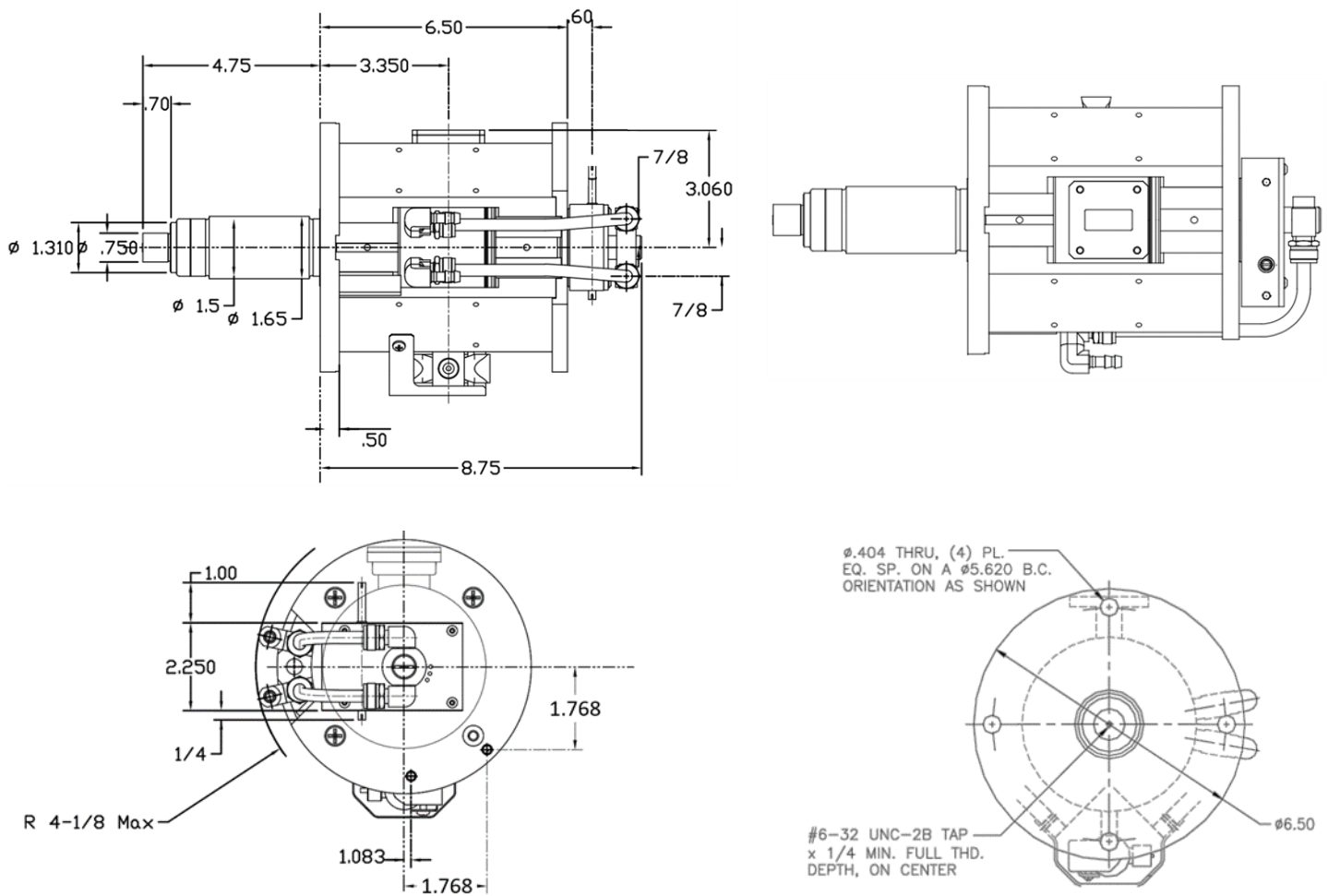

Detailed outline drawings are available on request. Specifications and features are subject to change without notice.

Stellant Systems is a partner for civil, military, and commercial organizations whose missions seek to ensure a safe, aware, and connected world. We are a premier manufacturer of critical spectrum and power amplification systems for defense, space, medical & scientific and industrial customers worldwide.

www.StellantSystems.com



Headquarters

3100 Lomita Blvd.
Torrance, California 90505
T: 310-517-6000
info@stellantsystems.com

1035 Westminster Dr.
Williamsport, Pennsylvania 17701
T: 570-326-3561

107 Woodmere Rd.
Folsom, California 95630
T: 916-351-4500

